

Model M-iClean U

Glass- and dishwasher

Installation, Operation and Maintenance manual



For the types of the series:
M007DWUC10M*-10 (+Heat recovery)
M007DWUC10M*-20 (+Heat recovery)
M007DWUC10M*-30 (+Heat recovery)



Before using the machine, carefully read the operating instructions, product description and safety instructions!

Contents

1	NOTES ON THE OPERATING INSTRUCTIONS	5
1.1	Product identification	5
1.2	Delivery contents	5
1.3	Related documents	5
1.4	Illustration	6
1.4.1	<i>Warnings</i>	6
1.4.2	<i>Notices on use</i>	6
1.4.3	<i>Safety symbols in the instructions</i>	7
2	GUARANTEE	7
3	SAFETY	7
3.1	Intended use	7
3.2	Misuse	8
3.3	Safety information	8
3.4	What to do in the event of an emergency	10
3.5	Requirements for the personnel	10
3.6	Electromagnetic compatibility	12
4	PRODUCT DESCRIPTION	12
4.1	Functional description	12
4.2	Overview illustration	13
4.3	Glass operating panel	13
4.4	LED indicator handle	15
4.5	Wash programs	15
4.6	Detergent and rinse aid	16
4.6.1	<i>Detergent</i>	17
4.6.2	<i>Rinse aid</i>	17
4.6.3	<i>Checking the correct dosing settings</i>	17
4.6.4	<i>Dosing units</i>	17
4.6.5	<i>Change of products</i>	18
4.7	Additional equipment	18
5	TECHNICAL DATA	19
6	TRANSPORT.....	19

7	REQUIREMENTS FOR INSTALLATION	20
7.1	Requirements for the installation location	20
7.2	Requirements for the wastewater connection	21
7.3	Requirements for the fresh water connection	21
7.4	Requirements for the electrical connection	22
8	INSTALLATION	23
8.1	Electrical installation	26
8.2	Connecting the fresh water pipe	27
8.3	Connecting the wastewater pipe	27
8.4	Connecting the detergent and rinse aid canisters	28
8.5	Terminating the installation	29
9	COMMISSIONING	29
9.1	Checking the requirements for commissioning	30
9.2	Performing commissioning	30
9.3	Venting (priming) the pipes	30
10	OPERATION/USE	31
10.1	Prior to switching on the machine	31
10.1.1	<i>Starting up the dishwasher</i>	34
10.2	Washing	35
10.2.1	<i>Useful information for loading the washware</i>	35
10.2.2	<i>Selecting the wash program</i>	36
10.2.3	<i>Starting the wash cycle</i>	36
10.2.4	<i>Unloading the washware</i>	38
10.3	Switching off the machine	39
10.4	Replacing the canisters	40
10.5	Malfunctions	41
10.5.1	<i>Messages</i>	42
11	MODIFYING THE SETTINGS	46
11.1	Resetting the pre-filter counter	48
11.2	Deactivating/activating the Bluetooth interface	49
11.3	Venting (priming) the pipes	49
11.4	Changing water	49
11.5	Adjusting the dosing quantity	50

11.5.1	<i>Changing the program assignment</i>	50
12	CLEANING	51
12.1	Cleaning the interior	51
12.2	Cleaning the glass operating panel	53
12.3	Cleaning outer stainless steel surfaces	54
12.4	Cleaning the surrounding area	54
12.5	Descaling	55
13	MAINTENANCE	56
13.1	Maintenance work	57
14	DISMANTLING AND DISPOSAL	60
14.1	Dismantling and disposal of the old machine	60
15	INDEX	61
16	NOTES	63

1 Notes on the operating instructions

The operating instructions as well as the applicable documents must be read before initial commissioning, kept for later use, and be accessible to the operator at all times. Failure to observe the operating instructions may result in damage to persons and property.

These operating instructions can be downloaded at the following address:
www.meiko.us or <https://partnet.meiko-global.com>.

1.1 Product identification

These operating instructions apply to the following machine types:

- Glass and dishwasher M-iClean US, UM+
- Glasswasher M-iClean UM

M-iClean US :	M007DWUC10M*-10	(+heat recovery)
M-iClean UM :	M007DWUC10M*-20	(+heat recovery)
M-iClean UM+ :	M007DWUC10M*-30	(+heat recovery)

1.2 Delivery contents

- M-iClean U dishwashing machine
- Matching racks for glassware and dishes depending on the machine model
- Connection hoses for fresh water and waste water
- Documentation

1.3 Related documents

In addition to these operating instructions, there are other documents:

- Short operating instructions
- Wiring diagram (behind the lower front panel)
- Data sheet with technical data and dimensions

1.4 Illustration

1.4.1 Warnings



WARNING – indicates a potentially hazardous situation which, if not avoided, could result in serious injury or death.



CAUTION – indicates a possible hazardous situation which, if not avoided, could result in minor or moderate injury or damage to property.

1.4.2 Notices on use

NOTE – indicates a possible hazardous situation which could result in damage to property.







IMPORTANT – indicates useful information about the product or its use.

Notes on using the document:

- A bullet point (•) indicates a list.
- Numerals (1.) indicate several action steps that must be executed in the specified order.
- Position numbers in the text that refer to position numbers in figures are shown in parentheses:
(1) Position number 1 in the figure
- The text is always below the figure and refers to it until a new image follows.

1.4.3 Safety symbols in the instructions

	Read the operating instructions		Disconnect from the power supply
	Potential equalization connection		Warning of dangerous electric voltage
	Manufacturer		

2 Guarantee

FOR WARRANTY ACTIVATION,

please contact your authorized MEIKO service partner.

For an ASA listing, please refer to either the QR code on the back cover of this manual or visit our website at www.meiko.us. You may also contact MEIKO service directly at (800) 868-3840.

You will be asked to schedule your performance and installation inspection. This inspection is provided FREE OF CHARGE to ensure that your new dishwasher is properly installed.

YOUR GUARANTEE IS NOT VALID UNTIL THIS FREE INSPECTION HAS BEEN COMPLETED BY YOUR AUTHORIZED SERVICE AGENCY.

3 Safety

Read and observe all safety information, instructions and symbols attached to the product. Improper use may result in damage to the product or danger to the user.

3.1 Intended use

The dishwasher is intended for commercial use only and is designed to wash dishes, cutlery, glasses, kitchen utensils, baking sheets, and containers. The washware must be suitable for commercial dishwashers.

3.2 Misuse

The dishwasher must not be used for:

- Washing kitchen utensils with electrical components
- Cleaning textiles, oven cloths or steel sponges
- Washing utensils made of iron or utensils that must not come into contact with foodstuff (e.g. ashtrays, candlesticks, etc)
- Cleaning living creatures
- Washing food for subsequent consumption
- Preparing foodstuff in the machine
- Taking wash water to prepare food or for drinking
- Washing support grids of electric ranges / grills of gas ranges
- Filling the machine from an external source (e.g. shower)
- Disposing of dirty water using the dishwasher (e.g. from a cleaning bucket)
- Standing or sitting on machine parts (e.g. door)
- Washing dishes made of wood or dishes that have wooden parts
- Washing plastic parts that are not resistant to heat and alkaline solution
- Washing parts made of aluminum (pots, containers, or trays, for example, with a suitable detergent only to avoid black discoloration)
- Conversions and modifications by means of non-approved conversion kits

3.3 Safety information

- Do not open the door while the program is running.
- Only operate the dishwasher when it is in perfect working order. All protection devices and housing parts as well as the tank cover sieve must be installed.
- Place washware, in particular small items, in the appropriate rack inserts.
- The washware must not come into contact with the wash arms/rinse arms of the dishwasher.
- Wear suitable work clothing, protective gloves and sturdy shoes.
- Do not wear rings, necklaces or other pieces of jewelry.
- Connect the suction lances of the dishwasher correctly to the canisters.
- Use optional bought-in parts in accordance with the associated instructions.

Electrical connection, see page 26.

- The power supply must be fused in accordance with the regulations and a lockable main switch provided in the local electrical installation.
- The electrical safety of this machine is only ensured if it is connected to a properly installed protective conductor system. It is very important to verify this fundamental safety feature. If in doubt, have the building wiring checked by an electrically skilled person.
- Carry out the protective measures as well as the equipotential bonding connection in accordance with the regulations of the local power supply companies as well as the locally applicable regulations.

Fresh water connection

- Installation components must be suitable and permitted in accordance with local regulations.
- Turn off the shut-off valve of the fresh water supply line before carrying out installation work. Check that all lines are securely connected and tight.
- When replacing an old machine with a new one, make sure that the existing feed hose is exchanged for the new feed hose supplied with the machine.

Environment

- Do not remove safety and warning notices from the dishwasher and ensure they are legible. Replace any damaged safety and warning notices.
- Do not process hazardous substances (hazardous to health, especially toxic, highly flammable and explosive substances) in the machine.
- Do not operate the dishwasher in a potentially explosive atmosphere.

Maintenance and repair

- Observe the maintenance specifications and intervals, including those of optional bought-in parts.
- Only use original spare parts from the manufacturer.
- Before opening the housing parts, ensure the local main switch has been disconnected from power and secured so that it cannot be switched on again.

Conversions

- Installation of an external dosing system is possible. Other modifications to the machine are not permissible.
- The safety of the dishwasher must not be impaired by the subsequent installation of a dosing system. Only use dosing technology approved by MEIKO.

3.4 What to do in the event of an emergency



- In dangerous situations, disconnect the machine from the power supply using the available main switch.

3.5 Requirements for the personnel

Installation, commissioning, instruction, repairs and maintenance of MEIKO products may only be carried out by authorized service partners.

The operator must check the area around the machine or system for hazards to other persons, e.g. children or persons with reduced physical, sensory or mental capabilities, or with a lack of experience or knowledge.

During operation it must be ensured that:

- Only adequately trained and instructed personnel are allowed to work on the machine.
- Personnel responsibilities for operation, maintenance and repairs must be clearly defined.
- Any personnel undergoing training are only allowed to work on the machine under the supervision of an experienced person.
- No person is under the influence of alcohol, drugs or medication (perceptual disorder).

The required qualifications for performing specific work on the machine are determined by MEIKO:

Activity	Persons	Trained operating personnel	In-house technician authorized by MEIKO	Service technician authorized by MEIKO
Operation, use		✓	✓	✓
Cleaning		✓	✓	✓
Checking safety devices			✓	✓
Troubleshooting		✓	✓	✓
Troubleshooting, mechanical		✓	✓	✓
Troubleshooting, electrical			✓*	✓
Maintenance			✓	✓
Repairs			✓	✓

* When trained as an electrically skilled person



Note

The instructions must be acknowledged in writing.

Qualified personnel, as defined by these operating instructions, are persons who:

- Are over 14 years of age.
- Due to their training, experience and instruction are able to perform the required activities.
- Are authorized to perform the required activities by the person responsible for safety of the machine.
- Have read and understood the operating instructions and corresponding safety information and will follow them.

3.6 Electromagnetic compatibility



NOTE:

This equipment has been tested and found to comply with the limits for a Class A digital device, pursuant to part 15 of the FCC Rules. These limits are designed to provide reasonable protection against harmful interference when the equipment is operated in a commercial environment.

This equipment generates, uses, and can radiate radio frequency energy and, if not installed and used in accordance with the instruction manual, may cause harmful interference to radio communications. Operation of this equipment in a residential area is likely to cause harmful interference in which case the user will be required to correct the interference at his own expense.

4 Product description

4.1 Functional description

The dishwasher has one wash cycle and one final rinse cycle.

A temperature controller keeps the set wash temperature at 155°F (66°C), minimum. A rotary pump circulates the water from the wash tank into the wash nozzles. The water jets hit the washware from different directions. This ensures uniform washing results.

The wash cycle is followed by a fresh water final rinse. A separate nozzle system rinses the washware using hot fresh water with at least 180°F (82°C). This heats up the washware for the subsequent drying process.

At the same time, the rinse water is used to regenerate the wash water; this reduces the degree of soiling of the wash water.

4.2 Overview illustration

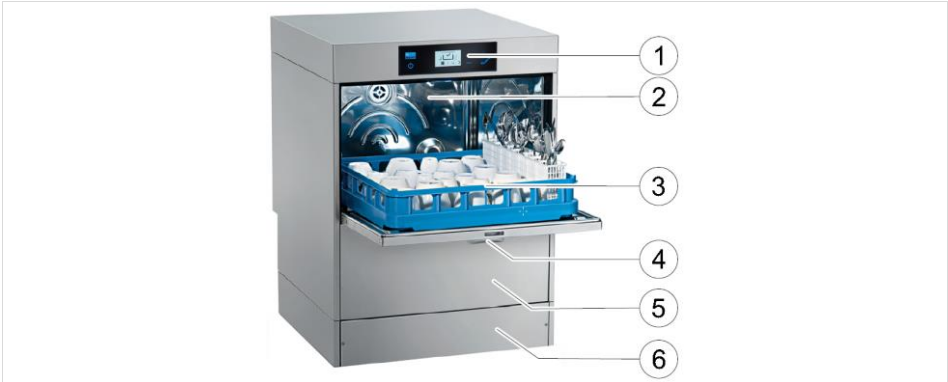



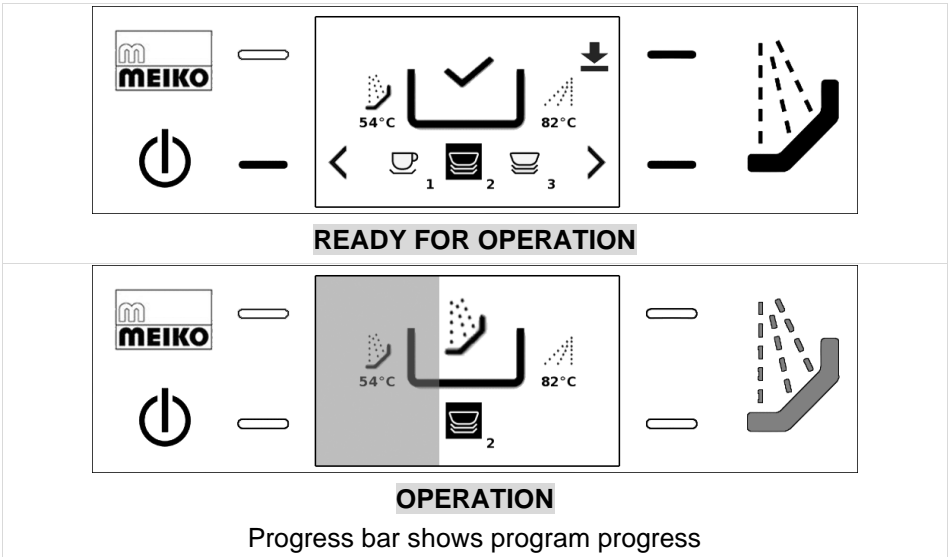

1 Glass operating panel (see page 13)	2 Wash chamber
3 Square rack	4 Door with LED indicator handle
5 Front panel (dosing units)	6 GiO MODULE in plinth (optional)

The dosing units for detergent and rinse aid are located behind the front panel (5).





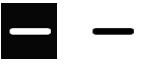





4.3 Glass operating panel

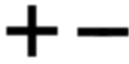

Keys

Key	Meaning	Key	Meaning
	<p>On/off key</p> <p>Filling/heating on or machine off</p>		Service access key (MEIKO key)
	<p>Confirmation keys</p> <ul style="list-style-type: none"> • Meaning/function is shown on the display next to the relevant key • Illuminated blue: function selectable • Illuminated green: function active 		<p>Program start key</p> <ul style="list-style-type: none"> • Flashing green: filling/heating active / memory start • Illuminated blue: ready for operation • Illuminated green: washing



Functions of the confirmation keys

Symbol	Meaning	Symbol	Meaning
	Open/close hood		Horizontal menu selection
	Action menu		Vertical menu selection
	Machine status and settings (i-menu)		Next digit in entry field
	Main menu		Change value
	Self-cleaning/Draining menu		Back without change
	Extended information for a message		Confirm selection

Program bar



Symbol	Meaning
	The selected program is shown inverted. For a detailed description of the wash programs, see page 15.

4.4 LED indicator handle

 <p>Blue</p> <p>Ready for operation</p>	 <p>Green</p> <p>Program is running</p>	 <p>Red</p> <p>Malfunction/important message</p>
---	---	--

4.5 Wash programs

M-iClean U

Program	Meaning	Washware
	Short, lowest water pressure	Lightly soiled washware
	Medium, medium water pressure	Normally soiled washware
	Long, high water pressure	Heavily soiled washware pots, containers, kitchen utensils

Program assignment

No.	Setpoint for boiler temperature		Setpoint for wash cycle time	
			Washing	Total
	[°F]	[°C]	[s]	[s]
1	180	82	80	95
2	180	82	135	150
3	180	82	195	210

NOTE

The concentration of the rinse aid in the water remains constant: if the rinse time is changed, the dosing amount of the rinse aid changes correspondingly.

4.6 Detergent and rinse aid



WARNING – Risk of injury from contact with chemicals

- Observe the safety data sheets and dosing recommendations of the chemical manufacturers.
- Use safety eyewear.
- Wear protective gloves.
- Do not mix different chemical products.



CAUTION

- Only use products that are suitable and approved for commercial dishwashers.
- Do not mix different detergents.

By default, the dishwasher is provided with dosing units for dosing liquid detergent/rinse aid. Manual dosing with powder cleaner is not intended.

4.6.1 Detergent

Detergents are alkaline (pH value should be >7) and are needed to dissolve soiling from the washware. If necessary, the concentration can be adjusted depending on the water quality, washware and degree of soiling. This setting is made during commissioning by an authorized MEIKO service technician or the chemicals supplier. The typical concentration is 0.256 oz/gallon (2 ml/l).

4.6.2 Rinse aid

Rinse aids are acidic (pH value should be between 2 and 7) and accelerate drying of the washware by reducing the surface tension of the water so that it can run off the washware quickly.

Dosing depends on the local water quality and is correct when the water drips evenly from the washware. This setting is made during commissioning by an authorized MEIKO service technician or the chemicals supplier. The typical concentration is 0.0256 oz/gallon (0.2 ml/l).

4.6.3 Checking the correct dosing settings

To check if the normal settings are correct for your chemicals, run three empty wash cycles without a rack to completely cycle the water system and obtain accurate test results. This will only take a few minutes. Then, run a sample load with soiled dishes and examine the results.

- If the detergent setting is too low, the dishes will not be adequately cleaned. In some cases, this can be corrected by simply selecting a longer program time (using the cycle selection II (Extended) or cycle selection III (Heavy) keys). However, the detergent concentration may also need to be adjusted.
- Low rinse aid settings may cause spotting and streaking on the dishes.
- If too much of one of the two chemicals is added, the additional chemicals will be wasted. Often, this is difficult to recognize unless you determine the period your chemicals supply will last. In case the chemicals are used up quickly, you might need to adjust the concentration of the chemicals.

Any adjustments to the factory-set chemical dosing system may ONLY be performed by an authorized MEIKO service partner. Changes by non-authorized personnel will void the guarantee.

4.6.4 Dosing units

The components of the dosing units are subject to high demands and must therefore be regularly maintained and, if necessary, replaced in accordance with the maintenance specification.

The service life of the dosing units and other dishwasher components depends on the use of suitable chemicals.

4.6.5 Change of products



CAUTION

When changing the detergent product (even to a product from the same manufacturer), crystallization may occur, which can lead to failure of the dosing system.

- When changing the detergent product, flush the dosing system using warm water.

Procedure for changing the detergent product:

1. Provide a suitable container with warm water and insert the suction lance.
2. Thoroughly flush the dosing system several times by **venting (priming) the lines**, see page 30.
3. Wipe the suction lance and put it into the canister with the other detergent product.
4. Refill the dosing system by **venting (priming) the lines**.

4.7 Additional equipment

Auto Safe

An internal boiler heating is regulated by the electronic control system to ensure a proper final rinse temperature, regardless of the fresh water temperature.

Soft Start

The wash water is pumped at a reduced pressure for the first few seconds of the wash cycle. This protects the washware from being damaged by a sudden burst of pressure.

Pressure booster pump

A pressure booster pump ensures that the final rinse pressure remains constant.

Drain pump

For wall drains or floor drains.

Aqua Stop

Automatically shuts the machine down if a water leak is detected.

5 Technical data

MEIKO has created a data sheet that shows machine dimensions as well as connected loads and consumption values.

For additional data, please refer to the data sheet.

Transport weight (including packaging)

Version	Weight, approx.
M-iClean US	154 lbs (70 kg)
M-iClean UM	174 lbs (79 kg)
M-iClean UM with GiO	183 lbs (83 kg)
M-iClean UM+	183 lbs (83 kg)

Noise emission

Workplace noise level LpA ≤ 70 dB(A).

6 Transport



IMPORTANT

During transportation and installation, the machine may only be positioned upright.

- Check that the delivery is complete immediately upon receipt by comparing it with MEIKO's order confirmation and/or the delivery note.
- If applicable, submit claims for any missing parts immediately to the freight forwarder and notify MEIKO.
- Check the machine for shipping damage.

NOTE

If you suspect any shipping damage, the shipping company and MEIKO (Customer Service (800) 868-3840) must be informed immediately in writing. Photograph any damaged parts and send the pictures to MEIKO.



WARNING – Danger of injury due to machine tipping

- Only qualified personnel may carry out transport works.
- Please observe the safety information on the packaging.
- Always transport the machine on a wooden frame only.
- Wear protective gloves and safety shoes.

The packaging is specifically designed to allow the machine to be moved safely and securely using a pallet jack or a sack truck. For safe transport, the dishwasher is supported by a special square timber frame.

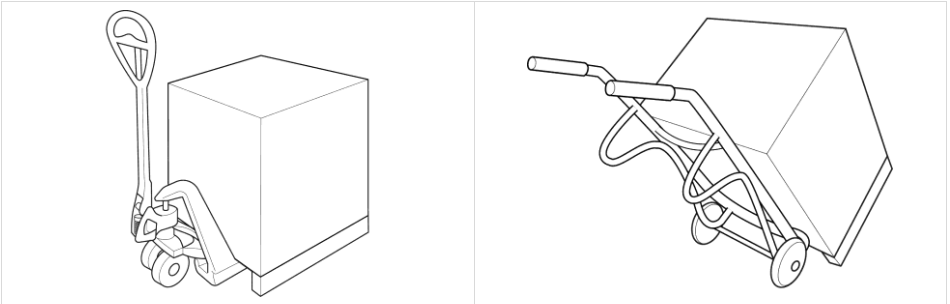

- Transport with care.
- Unpack the dishwasher only once transport is completed.
- Open the packaging using a suitable tool.

7 Requirements for installation

7.1 Requirements for the installation location

- The area **MUST** be frost-free. Freezing temperatures (32°F/0°C or lower) inhibit proper operation and can damage internal components.
- The area **MUST** have a firm floor surface. It is possible to compensate for uneven flooring by adjusting the feet.
- The area should be away from appliances, furniture or surfaces that can be damaged by steam. If this is not possible, these items should be protected from the small quantities of steam that are released during normal operation of the dishwasher.

7.2 Requirements for the wastewater connection

A wastewater pipe is integrated into the drain pump.

- Connect the drain hose to the on-site wastewater pipe.
- Observe the minimum height for the drain of 24" (610 mm).
- Minimum diameter of the drain: 1 ½" (38 mm).
- Depending on the dishwasher's field of application, a grease trap may be included, based on the general/location-specific regulations.
- Drain Water temperature can be in excess of 150 °F (65 °C). If a local plumbing code requires a lower drain temperature, please refer to optional Drain Water Tempering kit.

7.3 Requirements for the fresh water connection

Fresh water connections and their components must be made in accordance with local regulations. From a microbiological perspective, the fresh water must be of drinking water quality. This also applies to treated water.

Installation components and materials must be suitable and permitted in accordance with local regulations. A solenoid valve is integrated into the dishwashing machine's fresh water pipe. This, together with the leakage detector in the base drip tray in the subframe, ensures that the fresh water supply is shut off in the event of a leak in the machine.

Recommended water hardness:

- 1–3 grains per US gallon (gpg) without GiO MODULE
- 1–20 grains per U.S. gallon (gpg) with GiO MODULE

Recommended water temperature:

- 140°F (60°C)

Colder water will result in a longer preheat time during startup and will extend the wash cycle time. The required temperatures will still be reached.

Pressure range of the fresh water supply flow pressure upstream of the solenoid valve:

- 8.7–72.5 psi (0.6–5 bar)

Measures to ensure correct water pressure:

- If the minimum flow pressure is too low, increase the pressure using a pressure booster pump (not supplied as standard).
- If the maximum pressure is exceeded, limit the pressure using a pressure regulator (not supplied as standard).

Other measures:

- Make sure that no foreign iron particles can enter the machine via the fresh water connection. The same also applies to contamination by other metal particles (e.g. copper shavings).
- A dirt trap must be fitted in the fresh water supply to protect the solenoid valve. An additional dirt trap is not required.
- The feed hose must be sufficiently long so that the machine can be moved for servicing purposes.

7.4 Requirements for the electrical connection

**IMPORTANT**

The wiring diagram is located behind the large front panel of the dishwashing machine. It must remain in the dishwashing machine. The rating plate with the electrical connected loads is on the inside of the front panel and on the outside on the right side panel.

Requirements for the operator:

- The correct voltage and current type must be available.
- Safeguard the power supply in accordance with the regulations and provide it with an all-pole main switch in the permanently installed electrical installation.
- Connect the dishwashing machine to an equipotential bonding system.
- Do not connect any additional consumers to the fuse protecting the dishwashing machine.
- Electricity supply without a neutral conductor (N): When connecting to three-phase current, use a 4-pole terminal strip (L1, L2, L3, PE) or a 3-pole terminal strip (L1, L2, PE).

The products are intended for permanent connection to the locally available power supply and have been tested for the market accordingly. Any other type of electrical connection must be made by specially trained personnel.

Install the dishwashing machine in accordance with local regulations. In the absence of any such regulations, install the machine in accordance with the applicable requirements in the National Electrical Code, NFPA 70, Canadian Electrical Code (CEC), Part 1, CSA C22.1, and the Standard for Ventilation Control and Fire Protection of Commercial Cooking Operations, NFPA 96.

8 Installation



IMPORTANT

During transportation and installation, the machine may only be positioned upright.



IMPORTANT

This dishwasher is deactivated for shipment. Attempting to turn on the machine while it is deactivated will generate an ERROR 1 message in the display.

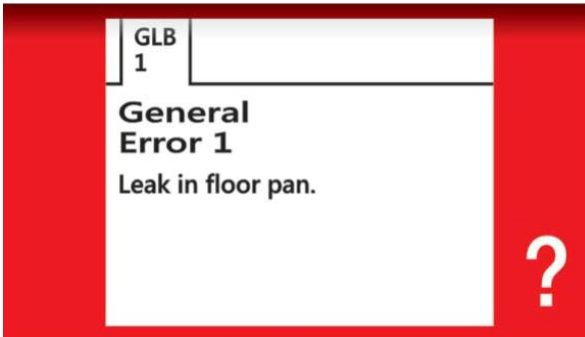

Initial message (first power-on)

To activate the machine, the owner/operator should call MEIKO at 1 (800) 868-3840 to schedule a free Performance and Installation Inspection, which activates the machine and your warranty.

For dishwashers with RO system (GiO):

This Inspection also activates your 3-month filter change interval. Carbon and sediment filters must be changed every 3 months. In addition, the machine requires a water supply with a hardness in the range of 1-20 grains per U.S. gallon. Failure to change the filters as scheduled, or use of the machine with incorrect water hardness, will void the warranty of your dishwasher's RO system.



IMPORTANT

Installation may be performed only by an authorized service technician.

M-iClean U without GiO MODULE

Back of the machine

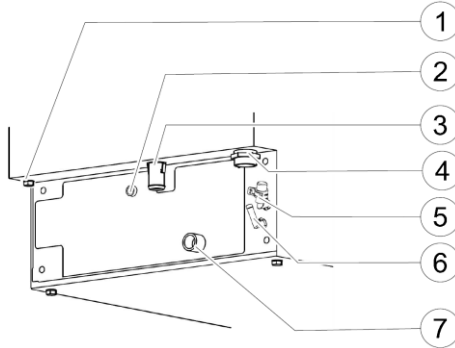

- 1 Protective equipotential bonding
- 2 Electric lead for detergent fill level sensor
- 3 Drain hose
- 4 Electrical connection
- 5 Dosing pipe for rinse aid
- 6 Dosing pipe for detergent
- 7 Fresh water connection

M-iClean U with GiO MODULE

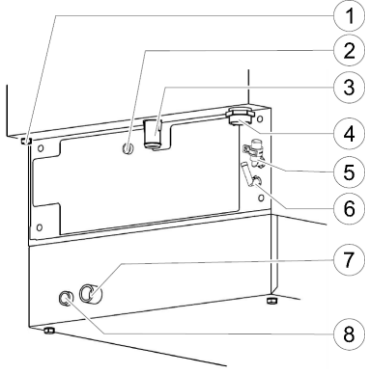
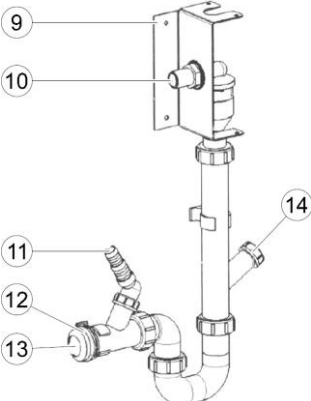
Back of the machine	Drain set with air gap for concentrate drain
 <p>A technical line drawing of the rear panel of the machine. Eight numbered callouts (1-8) point to various connection points and components: 1 is a bonding terminal, 2 is an electrical lead, 3 is a hose connection, 4 is a strain relief, 5 is a rinse aid dosing pipe connection, 6 is a detergent dosing pipe connection, 7 is a fresh water connection, and 8 is a concentrate drain connection.</p>	 <p>A technical line drawing of a vertical drain assembly. It features a wall-mounted bracket (9) with a concentrate drain inlet (10). A vertical pipe (14) extends downwards, equipped with a U-shaped air gap. At the bottom, there are three connection points: a machine drain inlet (11), a removable pipe connection adapter (12), and an unused connection (13).</p>
<ol style="list-style-type: none"> 1 Protective equipotential bonding 2 Electric lead for detergent fill level sensor 3 Connection for drain hose (to connection 11) 4 Strain relief for electrical supply 5 Connection for rinse aid dosing pipe 6 Connection for detergent dosing pipe 7 Fresh water connection 8 Concentrate drain (to connection 10) 	<ol style="list-style-type: none"> 9 Wall fixing (attach within 8 cm/3 inches of machine's rear wall) 10 Connection for concentrate drain (max. 24 inches/610 mm from front face) 11 Connection for machine drain 12 Pipe connection adapter (removable) 13 Unused

8.1 Electrical installation



WARNING – Danger to life from electric shock

- Work on the electrical system must only be conducted by qualified personnel who comply with the electrotechnical rules.
- Disconnect the machine from the power supply before removing any casing parts or working on the electrical system. To do this, turn the local main switch to **OFF** and ensure that it cannot be switched back on again.
- Attach all housing parts again before switching on the voltage again.

1. Turn the local main switch to OFF and ensure that it cannot be switched back on again.

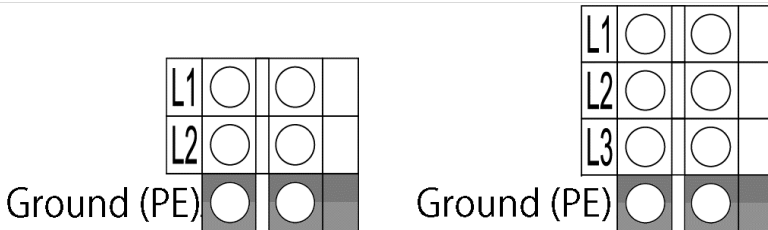

2. Connect the supply line in accordance with the figure and the wiring diagram.

Protective equipotential bonding



The screw for equipotential bonding is located on the back of the machine near the media connections.

8.2 Connecting the fresh water pipe

NOTE

Damage to property due to deposits

Deposits in the fresh water supply (tube sealant, metal particles, soldering agent, etc.) can result in damage to the dishwashing machine.

- Prior to connection, thoroughly flush the fresh water pipe using fresh water.
- Connect the fresh water connection of the dishwashing machine to the fresh water supply.



IMPORTANT

The fresh water pipe must be sufficiently long so that the dishwashing machine can be moved for servicing purposes.

8.3 Connecting the wastewater pipe

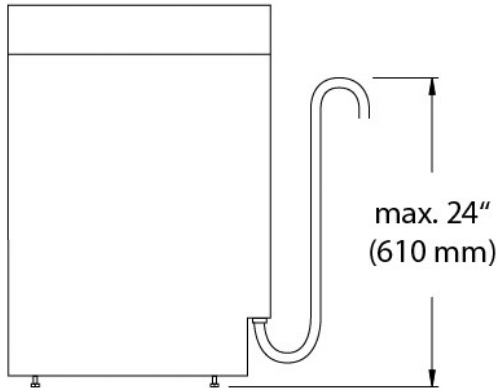

1. Route and connect the waste water hose of the dishwashing machine to the drain. The drain height must not be higher than 24 inches (610 mm).
2. Connect the drain hose of the GiO MODULE (optional) to the drain set (drain height not higher than 24 inches (610 mm)).
3. Install a grease separator (not supplied as standard) in the waste water pipe if this is required by the local regulations.

8.4 Connecting the detergent and rinse aid canisters



WARNING – Risk of injury from contact with chemicals

- Observe the safety data sheets and dosing recommendations of the chemical manufacturers.
- Use safety eyewear.
- Wear protective gloves.
- Do not mix different chemical products.

The delivery includes two suction hoses and accessories for the connection of the detergent and rinse aid canisters.



IMPORTANT

Suction lances with fill-level detection (optional) are already pre-installed. They simply need to be inserted into the canisters.

The attachment of conventional suction lances is shown here.

1. Clamp the hose for rinse aid (blue) and detergent (transparent) to the respective connections on the back of the machine with collar clamps.
2. Have the two canisters available.
3. Screw off the cover of the canisters.

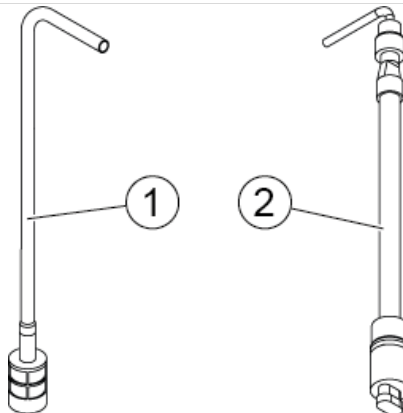

4. Insert the rinse aid suction lance (1) and the detergent suction lance (2) in the corresponding canister.
5. Slide the rinse aid hose (blue) and the detergent hose (transparent) onto the associated suction lance hoses. The suction lances must be inserted so they are resting on the bottom.
6. Clamp the two hoses using a collar clamp.

8.5 Terminating the installation



- Ensure the machine is level in both directions by using a spirit level.
- Compensate for an uneven floor by adjusting the feet.
- Table joints must be sealed with a detergent-resistant sealant (e.g. silicone).
- Check that the machine is stable.

For disposal of packaging materials, .

9 Commissioning



WARNING – Danger of injury when entering a danger zone

- Only qualified personnel may work on the machine.
- Remove unauthorized persons from the danger zone.
- Block off the danger zone and mark it for third parties.
- Always wear cut-resistant protective gloves when removing casing parts or working inside the machine.

9.1 Checking the requirements for commissioning

NOTE

Damage to property due to steam emission

Small quantities of steam may escape from the dishwasher. It is possible that adjacent furniture swells.

- Protect adjacent furniture from swelling.
- If possible, avoid installing the machine in an area close to furniture susceptible to swelling.

Requirements to be provided by the customer:

- Consistently frost-free storage and installation area.
- Anti-slip floor coverings provided in the work area around the machine.
- All connections are made correctly as described above.

9.2 Performing commissioning

To avoid damage or injuries during machine commissioning, please note the following points:

- Check supplier parts (e.g. external water handling devices). More detailed information can be found in the relevant operating instructions.
- Ensure that all tools and foreign parts are removed from the machine.
- Check if all casing parts are mounted on the machine.
- Turn on the main switch.
- Vent the pipes for the chemicals and check for correct dosing.

9.3 Venting (priming) the pipes

Venting of the detergent or rinse pipes must be performed during commissioning to fill the pipes with detergent and rinse aid.

The pipes must also be vented if the dosing units have sucked in air. This occurs if a canister is completely emptied during operation, or if one of the suction lances was not inserted all the way to the bottom of the canister.

1. When the display is switched off, press and hold the **MEIKO key** or open the door. If the machine is already filled and ready for operation, press the key beside the **on/off** symbol so **MACHINE OFF** appears on the display.
2. Press the key beside the symbol for the **action menu**.

3. For the detergent pipe: Confirm the first entry in the action menu, **VENT DETERGENT PIPE**, with the key beside the check mark. A timer shows the remaining time for the process. After the process, the display returns to the action menu.
4. For the rinse pipe: In the action menu, select **VENT RINSE PIPE** with the key beside the arrow and confirm with the key beside the check mark. A timer shows the remaining time for the process. After the process, the display returns to the action menu.
5. Return to the main screen with the key beside the **back** symbol.
6. Prepare the machine to operate with the key beside the **on/off** symbol.

10 Operation/use

10.1 Prior to switching on the machine



WARNING – Risk of injury from contact with chemicals

- Observe the safety data sheets and dosing recommendations of the chemical manufacturers.
- Use safety eyewear.
- Wear protective gloves.
- Do not mix different chemical products.

The dishwasher may only be used if the operating instructions have been read and understood. Incorrect operation may result in personal injury or damage to property.

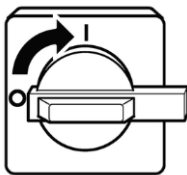

1. Turn on the main switch.

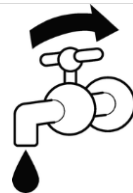

2. Turn on the tap.

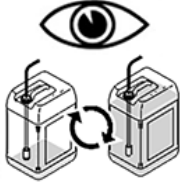

3. Check the detergent and rinse aid and replace in accordance with the manufacturer instructions, if necessary.

NOTE

If there is air in the hoses, the dosing function will not work properly. The hoses must be vented, see page 49.

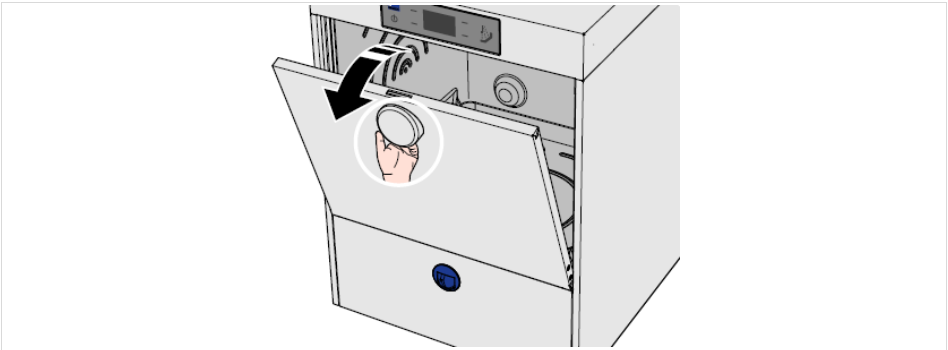

4. Open the door.

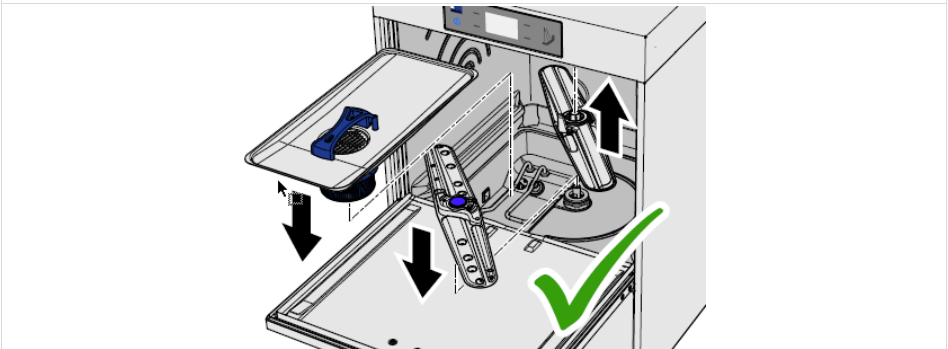

5. Insert the filter, the tank cover sieve, and the washing systems.

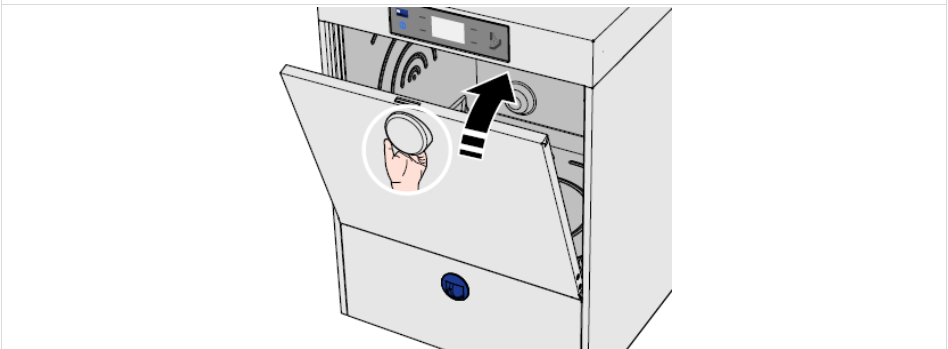

6. Close the door.

10.1.1 Starting up the dishwasher

- ▶ The time required for the machine to be ready to operate depends on the temperature of the water supply and the installed heating capacity.

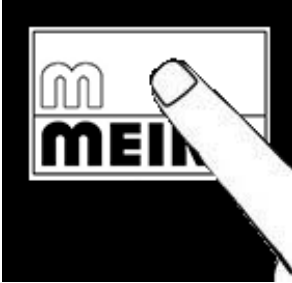

1. Touch the MEIKO key to activate the display.

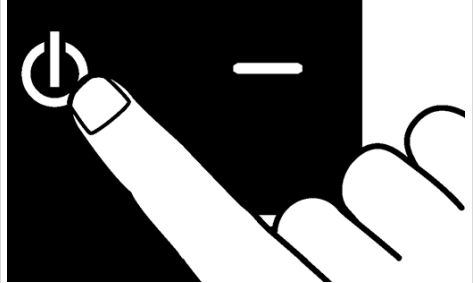

2. Touch the on/off key for 1 second.



Display shows **FILLING**.



Display shows **FILLING/HEATING**.



Display shows **READY FOR OPERATION**.

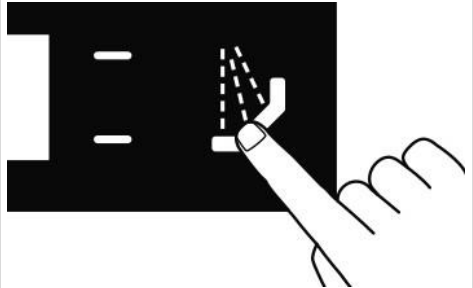





3. **Memory start:** Touch the program start key during **FILLING** or **FILLING/HEATING** to start the program immediately after the machine has heated up.

10.2 Washing

10.2.1 Useful information for loading the washware

When loading the racks with items of crockery and cutlery, observe the following points for optimum washing results:

	<ul style="list-style-type: none">• Hollow containers must always be loaded upside down in the rack. Otherwise, the water will not be drained from the washware and brilliant drying will not be possible.• Keep a space between the hollow containers so that they do not rub against each other. This prevents scratches.• Select a rack with appropriate compartment dividers so that the glasses will remain a correct position.
	<ul style="list-style-type: none">• Place plates, trays and compartment food trays into the racks at an angle. The inner surfaces face upwards.
	<ul style="list-style-type: none">• Do not place crockery items on top of each other in the rack so that the wash fluid can reach all surfaces easily and a short program duration is sufficient.• It is more efficient to load the rack with fewer items and run shorter wash cycles.
	<ul style="list-style-type: none">• If cutlery quivers are used, always insert the cutlery pieces into the cutlery quiver with the handles down.• Place spoons, knives and forks in cutlery quivers as far as possible, as cutlery of the same type can lie close together.• Do not crowd the cutlery in the individual cutlery quivers.

10.2.2 Selecting the wash program

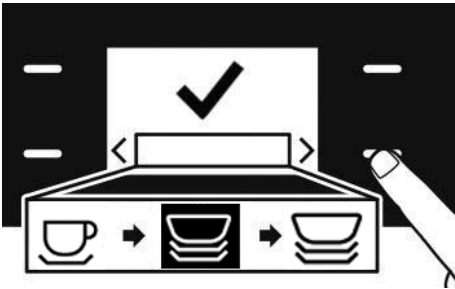

WASH PROGRAM 2
Runtime 120 s

1. Select the wash program with the confirmation keys. The selected program is shown inverted.

After a short waiting time, the display shows the program symbol, number, and runtime.

10.2.3 Starting the wash cycle



1. Pre-wash the washware (remove any large food waste, napkins, tooth picks, lemon peel, etc.).
2. Put the washware into the rack.

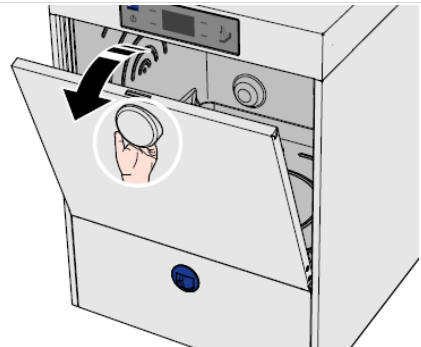

3. Open the door.



4. Insert the rack into the dishwashing machine.

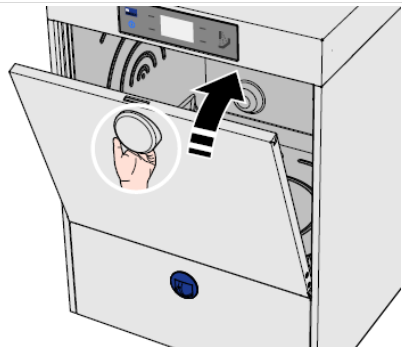

5. Close the door.

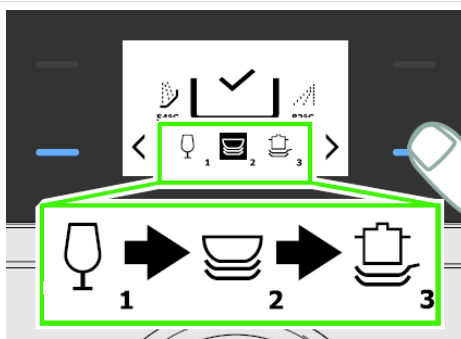

6. Change the program if required, see page 15.



7. Press the **program start key**. The program start key and the LED indicator handle illuminate green during the active wash cycle.

If the selected program is not long enough to heat up the boiler and tank water to the minimum temperature, the program duration must be extended. The program runs until the minimum temperatures are reached, but for a maximum of 5 minutes.

10.2.4 Unloading the washware



CAUTION – Danger of burns from hot wash water, hot washware and hot machine parts

- Wear protective gloves, if necessary.
- Let the washware cool down before emptying, if necessary.
- Let the machine cool down before touching machine parts, if necessary.
- Never open the door during a wash cycle.
- Only open and close the door using the designated handle(s).

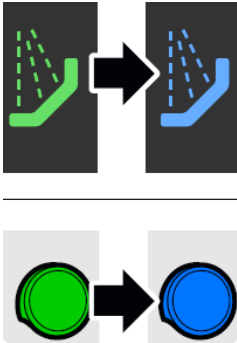

At the end of the program, the colour of the program start key changes and the LED indicator handle changes to blue and an acoustic signal sounds.

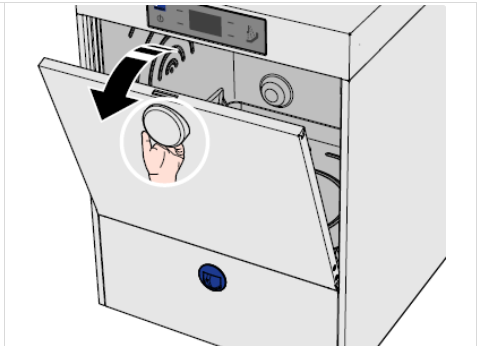

1. Open the door.

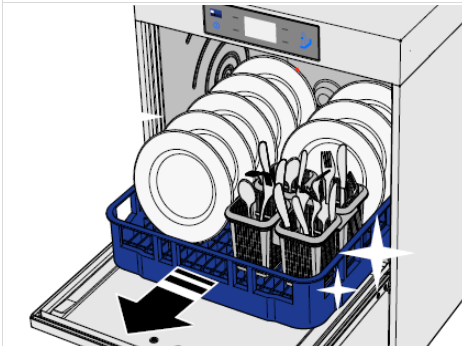

2. Carefully remove the rack.

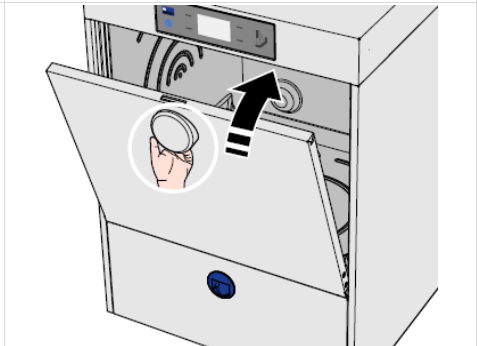

3. Close the door.

10.3 Switching off the machine



WARNING – Danger of scalding

- Do not open the door during self-cleaning.

The dishwashing machine is closed and does not have a rack inside.

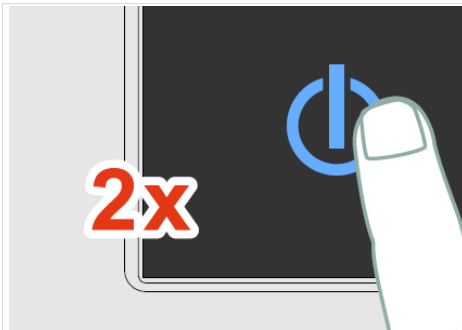

1. Press the **on/off key** twice.

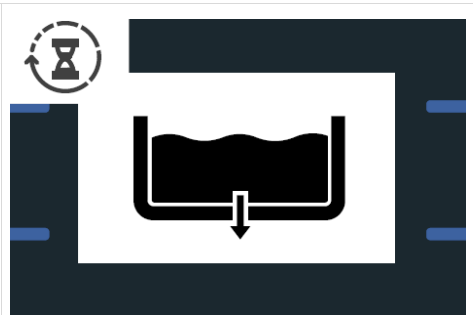

The self-cleaning program starts. The wash water is pumped out and the wash chamber is sprayed with hot fresh water.

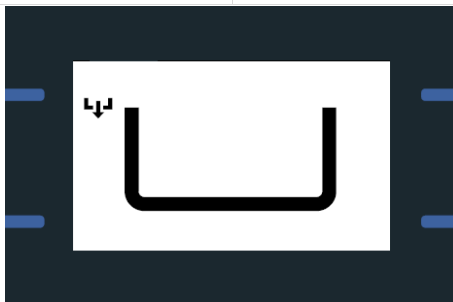

At the end of the program, the display shows the empty tank and goes out. The machine can now be cleaned, see page 51.

10.4 Replacing the canisters



WARNING – Risk of injury from contact with chemicals

- Observe the safety data sheets and dosing recommendations of the chemical manufacturers.
- Use safety eyewear.
- Wear protective gloves.
- Do not mix different chemical products.



IMPORTANT

The canisters for detergent and rinse aid are located in close proximity to the dishwashing machine.



IMPORTANT

When the detergent canister is empty, this is indicated on the display.

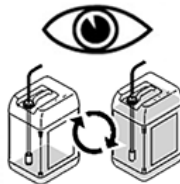

1. Remove the suction lance from the empty canister and insert it into a full canister.
2. If air has been sucked in: vent the pipes, see page 49.

10.5 Malfunctions

Many malfunctions can be rectified without the help of the customer service. The following malfunctions can be remedied by the operating personnel or the in-house technician.

Common malfunctions

Malfunction	Possible cause	Remedy
Dishwasher not filling up	No water available	Open shut-off valve
	Dirt trap clogged	Clean dirt trap
	Door open	Close door
Final rinse not spraying	No water available	Open shut-off valve
	Dirt trap clogged	Clean dirt trap
Streaks/smears on washware	Inappropriate rinse aid	Change product
	Incorrect dosing quantity	Adjust dosing quantity
	Water pre-treatment defective	Check water pre-treatment
Bubbles and streaks on washware	Overdosing	Have the dosing quantity adjusted
Water drops on washware	Underdosing	
Strong foam formation in wash tank	Dirt level too high	Pre-wash washware more thoroughly/change tank water more frequently
	Hand dishwashing detergent used	Do not use a foaming hand dishwashing detergent for pre-cleaning or for cleaning the machine. Foam can cause malfunctions in the dishwasher and poor washing results.
	Inappropriate detergent	Change product
	Inappropriate rinse aid	

Please contact your authorized MEIKO customer service if the listed measures cannot solve the problem.

For a list of authorized customer service points, please either scan the QR code on the back cover of these operating instructions, visit our website at www.meiko.us or give us a call at (800) 868-3840.

10.5.1 Messages

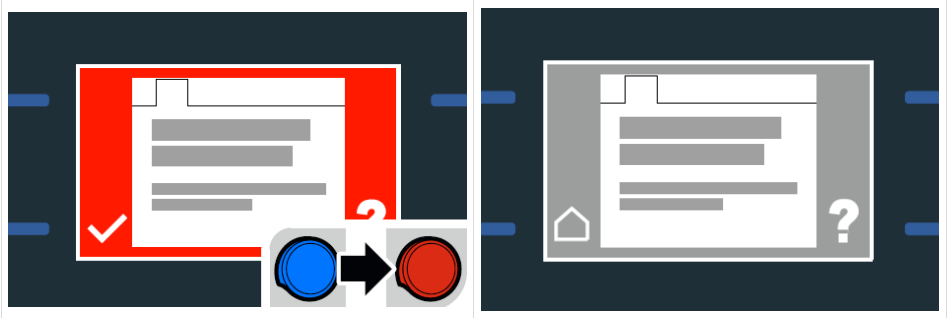

When a malfunction occurs, a gray or red message is shown on the display depending on the nature of the malfunction.

- Gray messages can be acknowledged using the relevant confirmation key.
- Red messages usually require the deployment of an authorized service technician.
- When these messages occur:

1, 100, 102, 104, 107, 108, 109, 110, 201, 203, 204, 206, 207, 208, 209, 330, 420, 425, 427, 600, 602-609, 613-618, 802, 832, 880, 901/902, 931-945, 960.

- Not possible to continue working
- Switch off on-site power supply
- Close on-site water supply
- Call service technician!

No.	Display text	Measures/remedy
6	Program canceled prematurely	Start wash cycle again
7	Door not closed	Close door
8	Door switch signals not identical: Switch left: "1" Switch right: "0"	Call service technician! Possible to continue work at limited capacity
9	Door switch signals not identical: Switch left: "0" Switch right: "1"	Call service technician! Possible to continue work at limited capacity
11	Carry out maintenance	Possible to continue working Call service technician!
12	Code entry wrong!	Enter correct code
14	Heat lost through open door!	Close door to prevent energy loss
15	Heat recovery cancellation	Allow heat recovery process to run to completion
17	Empty/close door	Close door
18	Water change/close door	
22	Attention: demo mode! (no washing/final rinsing)	Information about demo mode being active for trade fairs, exhibitions
101	Drainage level not reached	Check drainage sieve and clean if necessary Call a service technician if needed
103	Tank temperature not reached	Possible to continue working Call service technician
106	Wash time increase insufficient	If this message reoccurs, call a service technician
111	Water loss in wash tank	If this message reoccurs, call a service technician
112	Forced drainage due to permanently filled wash tank	Change water or drain machine at least once a day
114	Fine/coarse sieve missing	Correctly insert fine/coarse sieve If this message reoccurs, call a service technician
115	Drain pump active after triggering of the safety level	Possible to continue working
116	Refill error in wash tank	If this message reoccurs, call a service technician

No.	Display text	Measures/remedy
117	Top washing system blocked/missing	Ensure wash arm system can move freely
118	Bottom wash system blocked/missing	If applicable, insert wash arm system If necessary, remove dirt particles and ferrous metal particles from the magnet
127	Temperature increase not reached	If this message reoccurs, call a service technician
200	Boiler level not reached on time during filling	Open local water supply Check pre-filter/sieve and clean if necessary
205	Maximum final rinse cycles insufficient	Sort washware correctly Possible to continue working
212	Forced drainage due to permanently filled boiler	Change water or drain machine at least once a day
301	Lack of rinse aid	Refill/replace canister
311	Lack of detergent	Check position of suction lance and clean if necessary
406	Advance report: cartridge nearing end of life	Have a replacement cartridge ready Replace when notification 407 appears
407	Change demineralization cartridge	Change demineralization cartridge
408	Change reverse osmosis system pre-filter	Replace pre-filter
410	Water supply reverse osmosis module faulty	Open water inlet valve Check pre-filter/sieve and clean or replace if necessary
421	Insufficient water in holding tank	Open water inlet valve If necessary, call service technician
422	Max. level not reached in holding tank	
423	Water feed into holding tank insufficient	
426	Osmosis membrane blocked/dirty	Possible to continue working Check pre-filter and replace if necessary Call service technician!
500	Energy optimization active	No action required

No.	Display text	Measures/remedy
501	Energy optimization active Tank temperature not reached	Possible to continue working Call service technician!
502	Energy optimization active Wash time increase in tank insufficient	Possible to continue working If this message reoccurs, call a service technician
503	Energy optimization active Tank temperature rise not reached	If this message reoccurs, call a service technician
504	Energy optimization active Final rinse temperature not reached	Call service technician!
505	Energy optimization active Wash time increase on final rinse insufficient	If this message reoccurs, call a service technician
601	Power supply fault, frequency converter	Do not interrupt power supply when frequency converter is switched on Possible to continue working If this message reoccurs, call a service technician
610	Reduced Mode active	Possible to continue working If this message reoccurs, call a service technician
611	Overtemperature, frequency converter	Select a wash program with a lower pressure level or a shorter program runtime. If this message reoccurs, call a service technician
892	Communication with SMART WIRE node addr. 13	Possible to continue working Call service technician!
963	Bluetooth access error	Confirm message Possible to continue working Call service technician!
969	Backup battery critical	Confirm message Possible to continue work at limited capacity Call service technician!
971	Operating panel re-initializing	If this message reoccurs, call a service technician

Please contact your authorized MEIKO customer service if:

- There is an issue with the dishwasher, but no error code is displayed, OR
- An error code is displayed that is not listed here, OR
- The listed measures cannot solve the problem.

For a list of authorized customer service points, please either scan the QR code on the back cover of these operating instructions, visit our website at www.meiko.us or give us a call at (800) 868-3840.

11 Modifying the settings



The machine must be in **MACHINE OFF** mode. Touch the on/off key once for this. The machine does not need to be emptied!

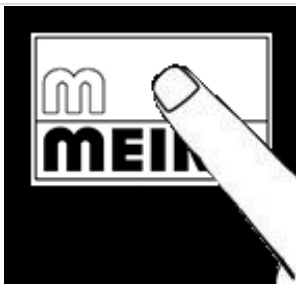

1. Touch the **MEIKO key** for approx. three seconds.



2. Enter the service code of the required level.











Level 1: Advanced settings (code 10001)

Level 4: Settings for the dosing technician (code 40044)







3. Confirm the message.

i-menu

i	Symbol	Level	Description
Languages		1, 4	Set display language
Wash tank		1, 4	Set descaling parameters View status
Final rinse		1, 4	View status
Chemicals		1	Set dosage quantity for detergent and rinse aid
Water treatment		1	Set degree of hardness and treatment parameters
Heat recovery		1	No user settings
Energy optimization		1, 4	No user settings
Frequency converter		1, 4	No user settings
Global		1	Set wash program channels and Bluetooth communication
Operational times		1,4	View loads, operational times, etc.
Daily protocol		1,4	View archived operational times, events, etc.
Wash programs		4	Set quantity of rinse aid and fine tune dosing
Settings		1,4	Set date/time, reset counter, display settings
General		1,4	View software version, machine serial number, machine type
Dosing technology		4	Dosing parameters for the dosing technician

Action menu

	Symbol	Description
Vent detergent pipe		Starts the dosing unit to vent the lines, e.g. if the canisters have become empty during operation.
Vent rinse pipe		
Manually start water change		Drain wash tank and refill.
Descaling		Starts descaling program.

11.1 Resetting the pre-filter counter



Reset interval until next change each time the reverse osmosis pre-filter is changed.

1. Switch to level 1 or 4, see page 46.
2. Call up the action menu using the relevant confirmation key.
3. Switch to the **Reset Counter** tab.
4. Select the **Pre-filter replacement interval** counter.
5. Confirm the selection by checking the box to reset the values.

11.2 Deactivating/activating the Bluetooth interface

11.3 Venting (priming) the pipes

1. When the display is switched off, press and hold the **MEIKO key** or open the door. If the machine is already filled and ready for operation, press the key beside the **on/off** symbol so **MACHINE OFF** appears on the display.
2. Press the key beside the symbol for the **action menu**.
3. For the detergent pipe: Confirm the first entry in the action menu, **VENT DETERGENT PIPE**, with the key beside the check mark. A timer shows the remaining time for the process. After the process, the display returns to the action menu.
4. For the rinse pipe: In the action menu, select **VENT RINSE PIPE** with the key beside the arrow and confirm with the key beside the check mark. A timer shows the remaining time for the process. After the process, the display returns to the action menu.
5. Return to the main screen with the key beside the **back** symbol.
6. Prepare the machine to operate with the key beside the **on/off** symbol.

11.4 Changing water

1. Switch to level 1, see page 46.
2. Call up the action menu using the relevant confirmation key.
3. Select **MANUALLY START WATER CHANGE**.
4. Confirm the selection by checking the box and start the water change.

11.5 Adjusting the dosing quantity

1. Switch to authorization level 1, the user configuration level, see page 46.



2. Call up the **i-menu** using the relevant confirmation key.
3. Select the **CHEMICALS** tab.
4. Select and confirm the **Parameter** item.
5. Select and confirm the **Rinse aid dosing quantity** or **Detergent dosing quantity** item.
6. Change the value with **+/-** and confirm.

11.5.1 Changing the program assignment



The wash programs can be configured according to the operator's requirements. Depending on the model, there is a choice of glass, dish, pot, and utensil wash programs. These differ in runtimes, boiler and tank temperatures, and the amount of water and chemicals used.

1. Switch to level 1, see page 46.
2. Select the **GLOBAL** item and confirm by checking the box.
3. Select the **GLOBAL parameter** item and confirm by checking the box.
4. Select the **Wash program position 1** item and confirm by checking the box.
5. Change the value with **+/-** and confirm by checking the box.

12 Cleaning

12.1 Cleaning the interior

⚠ CAUTION - Danger of burns from hot machine parts

- Allow the machine to cool down before cleaning.
- Wear protective gloves, if necessary.
- Only use the handles provided for opening or closing.

⚠ CAUTION – Property damage to electrics due to water ingress

- Never wash the machine, control cabinets and other electrical components using a water hose or high-pressure cleaner.
- Make sure that no water can enter the machine unintentionally.
- If installed at ground level, never flood the surrounding room.



IMPORTANT

Do not use a foaming hand dishwashing detergent for pre-cleaning the dishes. Do not use detergents or stainless steel cleaning agents on the interior of the machine. Foam causes malfunctions and poor washing results.

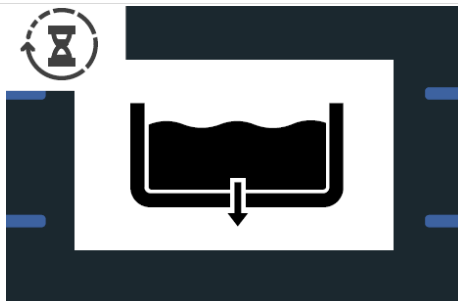

1. Switch off and drain the machine, see page 39.



2. Take the wash arms at the top/bottom out once a week.

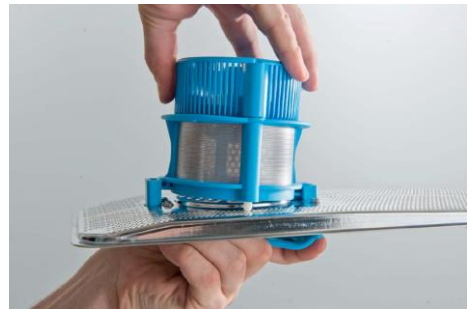

3. Remove the tank cover sieve and the filter. All parts to be cleaned are blue or have a blue handle.
4. Remove all food residues sticking to the tank, the tank heater, and the sieves using a brush.
5. Remove the strainer basket from the tank cover sieve.

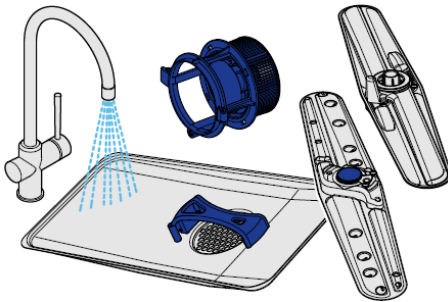

5. Rinse the filter, the sieve, and the wash and rinse arms thoroughly under running water using a soft brush.
6. Check the sieve at the bottom of the deep tank. If contaminated, remove the filter by pressing down on it and clean.
7. Wipe down the interior and the inside of the door with a soft cloth and warm water.
8. MEIKO recommends leaving the door open overnight to allow the machine to air out.
9. Reinstall all parts before commissioning. Note that the upper and lower wash arms are identical and interchangeable.

12.2 Cleaning the glass operating panel

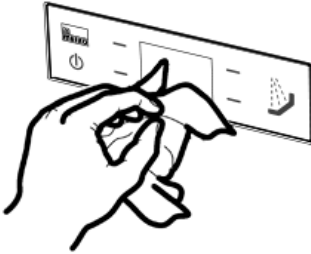

Wipe down the glass operating panel with a damp cloth.

12.3 Cleaning outer stainless steel surfaces



CAUTION – Property damage to stainless steel due to incorrect cleaning

Cleaning of stainless steel parts using inappropriate detergents, care products and cleaning utensils leads to damage, deposits or discoloration on the machine.

- Never use aggressive detergents or abrasives.
- Never use detergents that contain hydrochloric acid or chlorine-based bleachers.
- Do not use cleaning utensils previously used to clean non-stainless steel.

Clean the outside of the dishwasher, especially the door handle, once a day. Clean stainless steel surfaces with cleaning agents suitable for stainless steel only.

12.4 Cleaning the surrounding area

- Do not use aggressive detergents (e.g. aggressive tile cleaners).
- Make sure that no water can enter the machine unintentionally.
- Do not flood the surrounding area.

12.5 Descaling



WARNING – Danger of injury from contact with acids

- Observe the safety data sheets and dosing recommendations of the chemical manufacturers.
- Use safety eyewear.
- Wear protective gloves.
- Remove descaler residues from all parts of the machine without delay to avoid damage.

Operating the dishwasher using hard water causes lime scale deposits to occur on the boiler interior and tank interior. Descale the inside of the tank, if necessary.

The boiler can be descaled by a service technician only.

Operating the dishwasher using hard water can cause lime scale deposits to occur in the boiler interior and tank interior. If this occurs, it is necessary to descale the tank interior, the boiler casing, the tank heating, the boiler heating and the wash and rinse systems.

Notes on descaling:

- For descaling, only use products suitable for commercial dishwashers. Follow the manufacturer instructions.
- Completely flush the descaling agent out of the dishwasher. To do so, perform 3–6 wash cycles without a rack. Any remaining descaling agent residues must be removed using a soft cloth and hot water. Then, perform a final wash cycle.
- Drain the dishwasher at the end of the descaling process.
- Assign the task of descaling the boiler to the customer service, if necessary.

13 Maintenance



WARNING – Danger to life from electric shock

- Work on the electrical system must only be conducted by qualified personnel who comply with the electrotechnical rules.
- Disconnect the machine from the power supply before removing any casing parts or working on the electrical system. To do this, turn the local main switch to **OFF** and ensure that it cannot be switched back on again.
- Attach all housing parts again before switching on the voltage again.



WARNING – Danger of injury when entering a danger zone

- Only qualified personnel may work on the machine.
- Remove unauthorized persons from the danger zone.
- Block off the danger zone and mark it for third parties.
- Always wear cut-resistant protective gloves when removing casing parts or working inside the machine.



CAUTION – Danger of burns from hot wash water, hot washware and hot machine parts

- Wear protective gloves, if necessary.
- Let the washware cool down before emptying, if necessary.
- Let the machine cool down before touching machine parts, if necessary.
- Never open the door during a wash cycle.
- Only open and close the door using the designated handle(s).



IMPORTANT

Environmental damage due to improper disposal of liquids

Environmentally hazardous liquids may be used during work on the machine. Improper disposal of these liquids can cause environmental damage.

- Always capture, store and transport liquids in suitable containers.
- Never mix liquids.
- Dispose of liquids properly in accordance with local requirements.

13.1 Maintenance work



IMPORTANT

Maintenance work must only be carried out by an authorized in-house technician or an authorized service technician.

MEIKO recommends having the machine serviced by an authorized service technician at least once a year and concluding a maintenance contract. As part of the maintenance, an electrical safety inspection is also carried out. Wear parts are checked and replaced, if necessary, and the machine is tested. Neglected or improper maintenance increases the residual risk of unforeseen damage to property and persons, for which no liability will be assumed.

Wear parts include, for example:

- Dosing hoses
- Door seal
- Supply water hose

Maintenance work	Checked	Cleaned	Replaced	Maintenance requirement (minimum)
1. Pumps				
Check pumps for leaks and any visible damage				Once a year
Check pumps for running noise and correct function				Once a year
Check pump sieves for correct seating/function				Once a year
Check slide ring sealing/counter ring				Once a year
2. Wash systems				
Check water level in tank				Once a year
Check wash water pipe for leaks				Once a year
Check that wash arm is complete and generates correct spray pattern				Once a year
Check rotating arm hub				Once a year
3. Fresh water final rinse				
Check flow water pressure				Once a year
Check that rinse system is complete and generates correct spray pattern				Once a year
Check system for leaks				Once a year
4. Casing and built-in components				
Check casing parts and tank for damage and correct operation				Once a year
Check tank cover sieves				Once a year
Check boiler, hoses, clamps, plastic parts and seals				Once a year
5. Fresh water installation				
Check level control				Once a year
Check valves, clean dirt trap				Once a year
Check the air gap for cleanliness and tightness of the connections (visual inspection)				Once a year
For partial/full demineralization: check function				Once a year
With GiO-MODUL: Carry out pre-filter change				Every 6 months
6. Wastewater installation				
Check for tightness				Once a year
For drain pumps, check pressure hose position and draining behavior				Once a year

Maintenance work				Checked	Cleaned	Replaced	Maintenance requirement (minimum)
7. Electrical safety check (optional certificate)							
Perform visual check							Once a year
Check protective conductor							Once a year
Measure insulation resistance							Once a year
Measure current on protective conductor							Once a year
8. Detergent dosing							
Check dosing and adjust, if necessary							Once a year
Replace peristaltic hose and associated seals on the nozzles							Once a year
Check detergent dosing system is working and not leaking							Once a year
9. Rinse aid dosing							
Check dosing and adjust, if necessary							Once a year
Replace peristaltic hose and associated seals on the nozzles							Once a year
Check rinse aid dosing system is working and not leaking							Once a year
10. Test run with functional test of entire machine							
Check test wash and rinse results							Once a year
Visually check entire machine for leaks							Once a year
11. Water quality, temperature							
Drinking water	°F	gpg	µS/cm				Once a year
Water quality after water treatment (if available)	°F	gpg	µS/cm				Once a year

14 Dismantling and disposal

In addition to valuable raw materials and recyclable materials, the packaging and the old machine may also contain substances that are harmful to health and the environment but were required for the function and safety of the old machine.

14.1 Dismantling and disposal of the old machine



WARNING – Risk of injury from contact with chemicals

- Observe the safety data sheets and dosing recommendations of the chemical manufacturers.
- Use safety eyewear.
- Wear protective gloves.
- Do not mix different chemical products.

If applicable, wash machine components, containers, dosing units and hoses with fresh water to remove chemical residues. Wear suitable clothing (gloves, safety glasses) for this.



The machine is marked with this symbol. Please observe the local regulations for proper disposal of your old machine.

The components should be separated based on the material and recycled.

15 Index

A

Action menu	48
Adjusting the dosing quantity	50

C

Change of products.....	18
Changing the program assignment	50
Changing water	49
Cleaning	51
Descaling	55
Glass operating panel.....	53
Interior	51
Surrounding area	54

Cleaning outer stainless steel surfaces	54
---	----

Cleaning the glass operating panel	53
--	----

Cleaning the interior.....	51
----------------------------	----

Cleaning the surrounding area ...	54
-----------------------------------	----

Commissioning	29
Requirements.....	30

Connecting the detergent and rinse aid canisters	28
--	----

Connection	
Fresh water	27
Wastewater pipe.....	27

D

Delivery contents	5
Descaling	55
Designation	5
Detergent	17

Detergent and rinse aid.....	16
Dismantling.....	60
Dismantling and disposal	60
Disposal of the old machine	60
Dosing units	17

E

Electrical installation.....	26
Electromagnetic compatibility.....	12

F

Functional description	12
------------------------------	----

G

Glass operating panel	13
Guarantee	7

I

Illustration	6
i-menu	47
Installation	20, 23
Intended use	7

L

LED indicator handle	15
Level	
i menu.....	47

M

Maintenance.....	57
Malfunctions	41
Memory start	34
Menu overview	
i-menu	47

Messages.....	42	Requirements for the wastewater connection	21
Misuse.....	8	Resetting the pre-filter counter....	48
Modifying the settings	46	Rinse aid	17
N		S	
Noise emission.....	19	Safety	7
Notes on the operating instructions	5	Safety information	8
O		Safety symbols in the instructions.	7
Operation/use	31	Switching off	39
Overview illustration.....	13	Switching on	31
P		T	
Performing commissioning	30	Technical data	19
Preparation	31	Terminating the installation	29
Priming the pipes	30, 49	Transport	19
Product description	12	U	
Program		Useful information for loading the washware	35
Assignment.....	16	V	
Programs		Venting the pipes	30, 49
M-iClean U	15	W	
R		Wash programs	15
Related documents	5	Washing	
Replacing the canisters	40	Selecting the wash program	36
Requirements for the electrical connection.....	22	Starting the wash cycle.....	36
Requirements for the fresh water connection.....	21	Starting up the dishwasher	34
Requirements for the installation location.....	20	Unloading the washware.....	38
Requirements for the personnel .	10	What to do in the event of an emergency.....	10



Scan QR code to access MEIKO U.S. ASA listings.
ASA listing can also be accessed at
www.meiko.us



**MEIKO Maschinenbau
GmbH & Co. KG**
Englerstraße 3
77652 Offenburg
Germany
www.meiko-global.com
info@meiko-global.com

MEIKO USA, Inc.
1349 Heil Quaker Boulevard La
Vergne, TN 37086
Phone (615) 399-6600
Toll Free (800) 55 MEIKO
Fax (615) 399-6620
sales@meiko.us
24H Toll Free Service +1 800 868
3840
service@meiko.us